

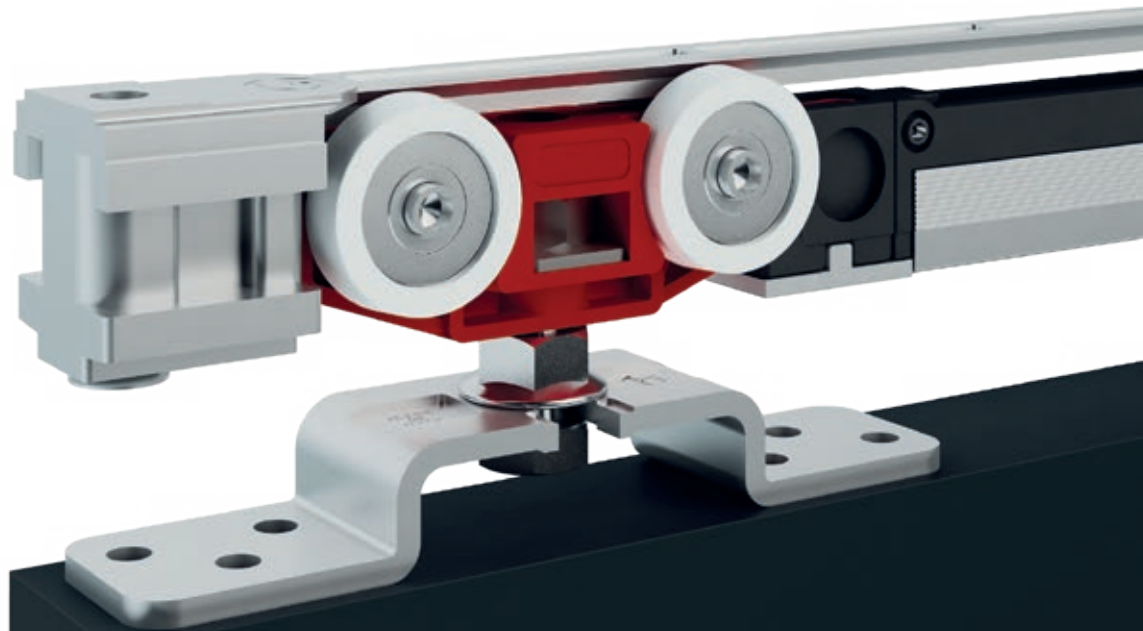

Classic

Slides with standard bracket
Scorrevoli con staffa normale



Classic

PATENTED

Classic is the **standard bracket** sliding system for wooden doors, available with traditional, oil damper and air damper stoppers.

Economic and easy to assemble, with floor distance of only 6 mm.

Classic system (kg. 50-80-120) is equipped with a damping system in rubber which significantly reduces the noise level.

Classic è il sistema di scorrimento per porte in legno con **staffa tradizionale**, disponibile con fermi tradizionali, fermi ammortizzati ad aria e fermi idraulici.

Economico e facile da montare, ha uno spazio luce inferiore di soli 6 mm.

Classic, inoltre, è dotato (nelle portate da kg. 50-80-120) di un sistema di ammortizzamento in gomma che riduce sensibilmente la rumorosità.





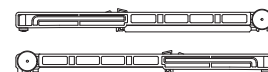
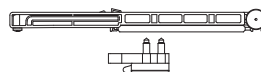

















**N.2 STANDARD STOPPERS
N.2 FERMI STANDARD**

**N.1 SOFT DAMPER STOPPER +
N.1 STANDARD STOPPER
N.1 FERMO AMMORTIZZATO +
N.1 FERMO STANDARD**

**N.2 SOFT DAMPER STOPPERS
N.2 FERMI AMMORTIZZATI**

 30 kg	 Min. 600 mm	 Min. 600 mm	 Min. 600 mm
	PAG. 10	PAG. 10	PAG. 10
 40 kg	 Min. 600 mm		
	PAG. 11		
 50 kg			
 80 kg	 Min. 600 mm		
	PAG. 14		
 120 kg			
 160 kg	 Min. 700 mm		
	PAG. 16		
 180 kg			
 240 kg	 Min. 700 mm		
	PAG. 17		
 250 kg			

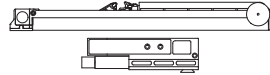
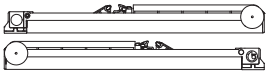

N.2 FLUID DAMPERS
N.2 FERMI AMMORTIZZATI FLUID

N.1 FLUID DAMPER + N.1 SHOCK ABSORBER
N.1 FERMO AMMORTIZZATO FLUID + N.1 FERMO A PINZA AMMORTIZZATO

N.2 SHOCK ABSORBERS
N.2 FERMI A PINZA AMMORTIZZATI

N.2 HYDRAULIC STOPPERS (NAVAL SECTOR)
N.2 FERMI IDRAULICI (SETTORE NAVALE)

●	●	●	
NEW Min. 740 mm	NEW Min. 600 mm	NEW Min. 600 mm	
PAG. 12	PAG. 12	PAG. 12	
●	●	●	●
NEW Min. 740 mm	NEW Min. 600 mm	NEW Min. 600 mm	Min. 700 mm
PAG. 13	PAG. 13	PAG. 13	PAG. 14
●	●	●	
NEW Min. 740 mm	NEW Min. 600 mm	NEW Min. 600 mm	
PAG. 15	PAG. 15	PAG. 15	
		●	
		NEW Min. 700 mm	
		PAG. 16	
		●	
		NEW Min. 800 mm	
		PAG. 17	

Classic

Slides with standard bracket
Scorrevoli con staffa normale

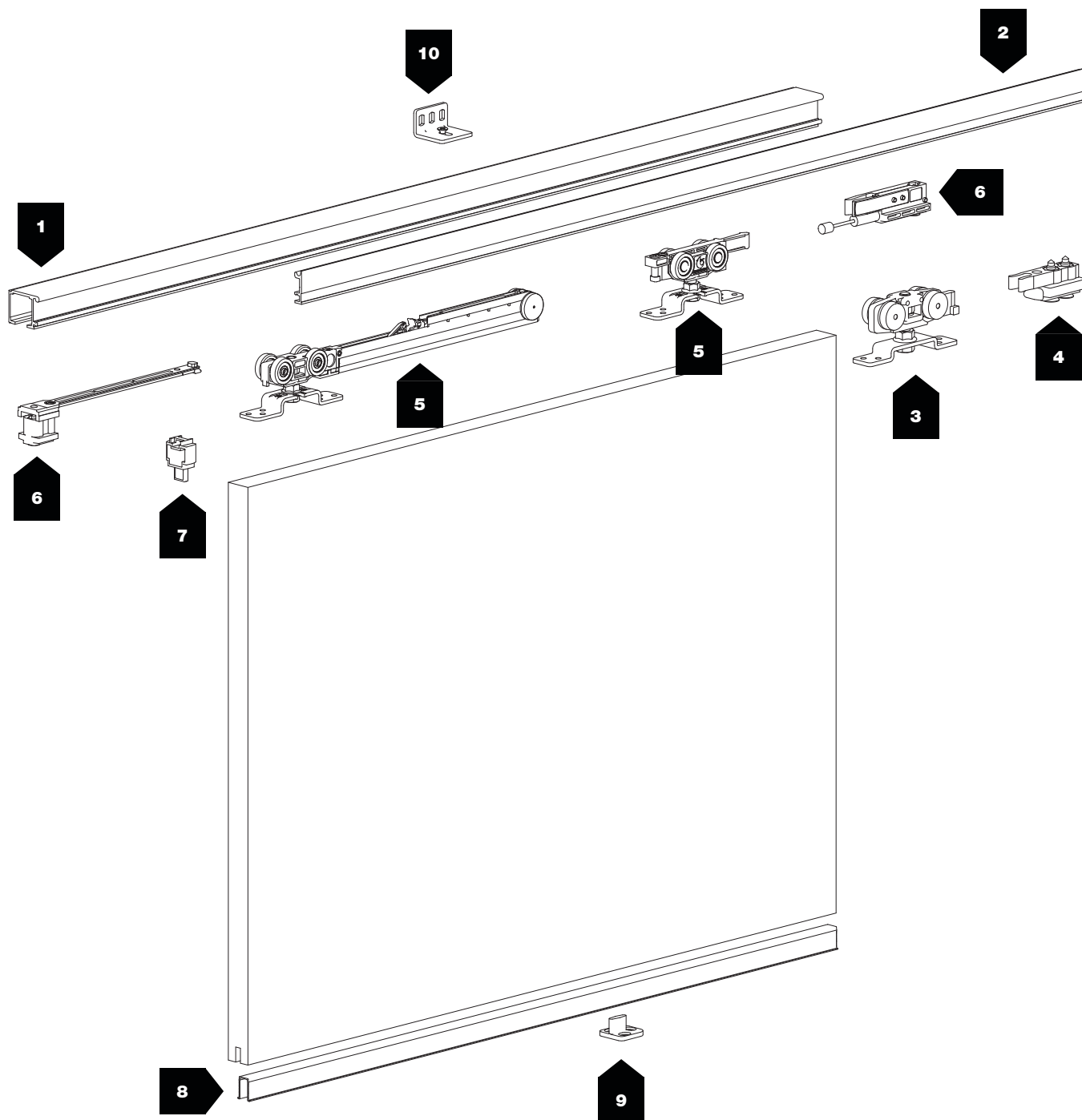

600 ÷ 1500 mm



30 ÷ 250 kg



6 ÷ 15 mm

N°	Barcode	Image	kg	Category	N°	Barcode	Image	kg	Category	
1	2660 8 00 0.02660 8 01 0.02660		-	STANDARD	1	3480 8 00 0.03480 8 01 0.03480		-	STANDARD NEW	
	2670 8 00 0.02670 8 01 0.02670		-	OPTIONAL +		201 8 00 0.00201 8 01 0.00201		-	STANDARD	
	1280 8 00 0.01280 8 01 0.01280		-	STANDARD		234 8 00 0.00234 8 01 0.00234		-	OPTIONAL +	
	1080 8 00 0.01080 8 01 0.01080		-	OPTIONAL +		1710 8 00 0.01710 8 01 0.01710		-	OPTIONAL +	
	1359 8 00 0.01359 8 01 0.01359		-	OPTIONAL +		1720 8 00 0.01720 8 01 0.01720		-	OPTIONAL +	
	1559 8 00 0.01559 8 01 0.01559		-	OPTIONAL +		3490 8 02 0.03490		-	OPTIONAL + NEW	
	1700 8 00 0.01700 8 01 0.01700		-	OPTIONAL +		3491		-	OPTIONAL + NEW	
	1160 8 00 0.01160 8 01 0.01160		-	STANDARD		3	2663/T		30	
	160 8 00 0.00160 8 01 0.00160		-	OPTIONAL +			41/T		40	
	1660 8 00 0.01660 8 01 0.01660		-	OPTIONAL +			81/T		80	

Classic

Slides with standard bracket
Scorrevoli con staffa normale

N°	Barcode	Image	kg		N°	Barcode	Image	kg	
3	1626/T		80		4	2661		30	
	1161/T		160			3358/50		50	FLUID NEW
	203/T		240			3358/120		80÷120	FLUID NEW
	2662/T		30			3488		180÷250	FLUID NEW
4	2657		30		5	3352/050		50	FLUID NEW
	46		40			3352/080		80	FLUID NEW
	84		80			3352/120		120	FLUID NEW
	1627/10		80		6	3355/050		50	FLUID NEW
	1163		160			3355/080		80	FLUID NEW
	1165		240			3355/120		120	FLUID NEW

N°	Barcode	Image	kg	FLUID NEW	N°	Barcode	Image	kg	FLUID NEW
6	3485/180		180	FLUID NEW	9	93		120	
	3485/250		250	FLUID NEW		90		30÷120	OPTIONAL +
	3354		50÷120	FLUID NEW		124		160÷240	
7	3347		50÷120		2855		180÷250	NEW	
8	121 8 23 0.00121		30÷120	OPTIONAL +	409		-		
	705 8 23 0.00705		40÷120	OPTIONAL +	10	126		30	
	707 8 00 0.00707 8 01 0.00707		40÷120	OPTIONAL +		127/D/V		40÷120	
	760/N 8 14 0.00760		160÷240			163/DV		160÷250	
9	1032		30		163/PV		160÷250		
	45		40÷80						

Classic

Slides with standard bracket
Scorrevoli con staffa normale

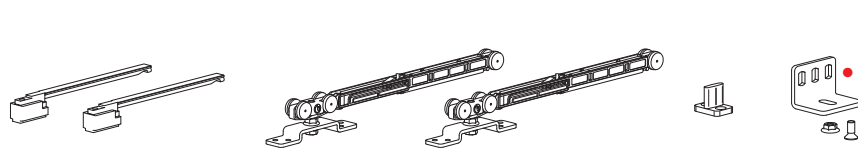

ART. 2660
(8000.02660)
(8010.02660)



30 kg



N.2 Soft damper stoppers
N.2 Fermi ammortizzati



Turned wheels
Ruote tornite

KIT	•	N° 3	OLD CODE	NEW CODE	Min. 600 mm	TRACK-BINARIO	4x
			2662/2662/G/C	K.030.6.1.C		—	
		—	2662/2662/G/S	K.030.6.1.S	Min. 600 mm	—	4x
BLISTER	•	N° 4	2662/2662/150C	B.030.6.1.C150	700 ÷ 850 mm	1500 mm	4x
		N° 5	2662/2662/165C	B.030.6.1.C165	860 ÷ 950 mm	1650 mm	4x
		N° 5	2662/2662/200C	B.030.6.1.C200	960 ÷ 1100 mm	2000 mm	4x
		N° 6	2662/2662/250C	B.030.6.1.C250	1110 ÷ 1350 mm	2500 mm	4x
		N° 7	2662/2662/300C	B.030.6.1.C300	1360 ÷ 1600 mm	3000 mm	4x
		—	2662/2662/150S	B.030.6.1.S150	700 ÷ 850 mm	1500 mm	4x
		—	2662/2662/165S	B.030.6.1.S165	860 ÷ 950 mm	1650 mm	4x
		—	2662/2662/200S	B.030.6.1.S200	960 ÷ 1100 mm	2000 mm	4x
		—	2662/2662/250S	B.030.6.1.S250	1110 ÷ 1350 mm	2500 mm	4x
		—	2662/2662/300S	B.030.6.1.S300	1360 ÷ 1600 mm	3000 mm	4x

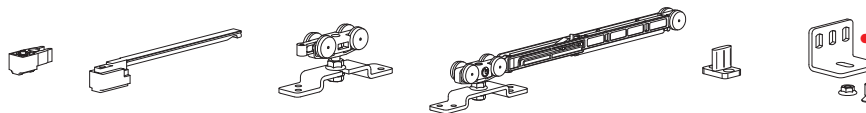

ART. 2660
(8000.02660)
(8010.02660)



30 kg



N.1 Soft damper stopper
N.1 Fermo ammortizzato



N.1 Standard stopper
N.1 Fermo standard



Turned wheels
Ruote tornite

KIT	•	N° 3	OLD CODE	NEW CODE	Min. 600 mm	TRACK-BINARIO	4x
			2662/2663/G/C	K.030.5.1.C		—	
		—	2662/2663/G/S	K.030.5.1.S	Min. 600 mm	—	4x
BLISTER	•	N° 4	2662/2663/150C	B.030.5.1.C150	700 ÷ 850 mm	1500 mm	4x
		N° 5	2662/2663/165C	B.030.5.1.C165	860 ÷ 950 mm	1650 mm	4x
		N° 5	2662/2663/200C	B.030.5.1.C200	960 ÷ 1100 mm	2000 mm	4x
		N° 6	2662/2663/250C	B.030.5.1.C250	1110 ÷ 1350 mm	2500 mm	4x
		N° 7	2662/2663/300C	B.030.5.1.C300	1360 ÷ 1600 mm	3000 mm	4x
		—	2662/2663/150S	B.030.5.1.S150	700 ÷ 850 mm	1500 mm	4x
		—	2662/2663/165S	B.030.5.1.S165	860 ÷ 950 mm	1650 mm	4x
		—	2662/2663/200S	B.030.5.1.S200	960 ÷ 1100 mm	2000 mm	4x
		—	2662/2663/250S	B.030.5.1.S250	1110 ÷ 1350 mm	2500 mm	4x
		—	2662/2663/300S	B.030.5.1.S300	1360 ÷ 1600 mm	3000 mm	4x

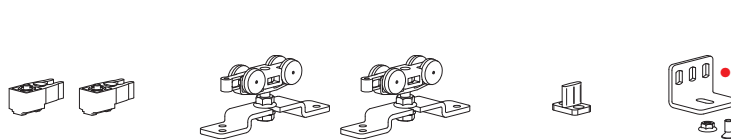

ART. 2660
(8000.02660)
(8010.02660)



30 kg



N.2 Standard stoppers
N.2 Fermi standard



Turned wheels
Ruote tornite

KIT	•	N° 3	OLD CODE	NEW CODE	Min. 600 mm	TRACK-BINARIO	5x
			2663/2663/G/C	K.030.0.1.C		—	
		—	2663/2663/G/S	K.030.0.1.S	Min. 600 mm	—	5x
BLISTER	•	N° 4	2663/2663/150C	B.030.0.1.C150	700 ÷ 850 mm	1500 mm	4x
		N° 5	2663/2663/165C	B.030.0.1.C165	860 ÷ 950 mm	1650 mm	4x
		N° 5	2663/2663/200C	B.030.0.1.C200	960 ÷ 1100 mm	2000 mm	4x
		N° 6	2663/2663/250C	B.030.0.1.C250	1110 ÷ 1350 mm	2500 mm	4x
		N° 7	2663/2663/300C	B.030.0.1.C300	1360 ÷ 1600 mm	3000 mm	4x
		—	2663/2663/150S	B.030.0.1.S150	700 ÷ 850 mm	1500 mm	4x
		—	2663/2663/165S	B.030.0.1.S165	860 ÷ 950 mm	1650 mm	4x
		—	2663/2663/200S	B.030.0.1.S200	960 ÷ 1100 mm	2000 mm	4x
		—	2663/2663/250S	B.030.0.1.S250	1110 ÷ 1350 mm	2500 mm	4x
		—	2663/2663/300S	B.030.0.1.S300	1360 ÷ 1600 mm	3000 mm	4x

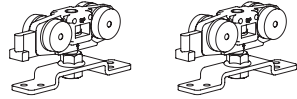
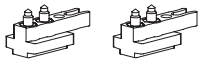

ART. 1280
(8000.01280)
(8010.01280)

				OLD CODE	NEW CODE			
KIT	●	N° 4	40/T/G/NOR/CON	K.040.0.1.C	Min. 600 mm	—	—	5x
		—	40/T/G/NOR/SEN	K.040.0.1.S	Min. 600 mm	—	—	5x
BLISTER		N° 4	40/T/P/NR150CON	B.040.0.1.C150	700 ÷ 850 mm	1500 mm	4x	
		N° 5	40/T/P/NR165CON	B.040.0.1.C165	860 ÷ 950 mm	1650 mm	4x	
	●	N° 5	40/T/P/NR200CON	B.040.0.1.C200	960 ÷ 1100 mm	2000 mm	4x	
		N° 6	40/T/P/NR250CON	B.040.0.1.C250	1110 ÷ 1350 mm	2500 mm	4x	
		N° 7	40/T/P/NR300CON	B.040.0.1.C300	1360 ÷ 1600 mm	3000 mm	4x	
		—	40/T/P/NR150SEN	B.040.0.1.S150	700 ÷ 850 mm	1500 mm	4x	
		—	40/T/P/NR165SEN	B.040.0.1.S165	860 ÷ 950 mm	1650 mm	4x	
		—	40/T/P/NR200SEN	B.040.0.1.S200	960 ÷ 1100 mm	2000 mm	4x	
		—	40/T/P/NR250SEN	B.040.0.1.S250	1110 ÷ 1350 mm	2500 mm	4x	
		—	40/T/P/NR300SEN	B.040.0.1.S300	1360 ÷ 1600 mm	3000 mm	4x	



40 kg



N.2 Standard stoppers
N.2 Fermi standard



Turned wheels
Ruote tornite

Classic

Slides with standard bracket
Scorrevoli con staffa normale

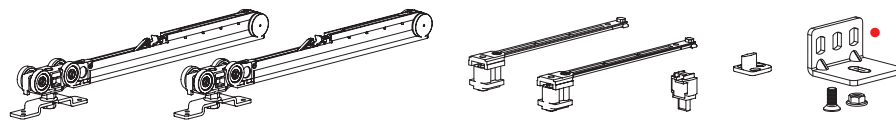

ART. 1280
(8000.01280)
(8010.01280)

FLUID



50 kg



N.2 Fluid dampers
N.2 Fermi ammortizzati
Fluid



Ball bearings
Cuscinetti a sfera

			OLD CODE	NEW CODE		TRACK-BINARIO 	
KIT	●	N° 4	—	K.050.2.1.C	Min. 740 mm	—	4x
			—	K.050.2.1.S	Min. 740 mm	—	4x
BLISTER	●	N° 4	—	B.050.2.1.C150	740 ÷ 850 mm	1500 mm	4x
		N° 5	—	B.050.2.1.C165	860 ÷ 950 mm	1650 mm	4x
		N° 5	—	B.050.2.1.C200	960 ÷ 1100 mm	2000 mm	4x
		N° 6	—	B.050.2.1.C250	1110 ÷ 1350 mm	2500 mm	4x
		N° 7	—	B.050.2.1.C300	1360 ÷ 1600 mm	3000 mm	4x
		—	—	B.050.2.1.S150	740 ÷ 850 mm	1500 mm	4x
		—	—	B.050.2.1.S165	860 ÷ 950 mm	1650 mm	4x
		—	—	B.050.2.1.S200	960 ÷ 1100 mm	2000 mm	4x
		—	—	B.050.2.1.S250	1110 ÷ 1350 mm	2500 mm	4x
		—	—	B.050.2.1.S300	1360 ÷ 1600 mm	3000 mm	4x

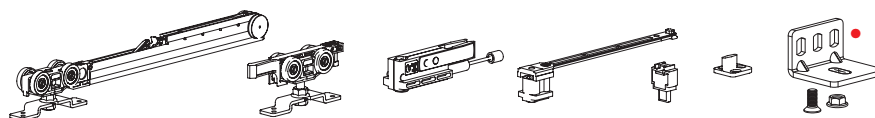

ART. 1280
(8000.01280)
(8010.01280)

FLUID



50 kg



N.1 Fluid damper
N.1 Fermo ammortizzato
Fluid



N.1 Shock absorber
N.1 Fermo a pinza
ammortizzato



Ball bearings
Cuscinetti a sfera

			OLD CODE	NEW CODE		TRACK-BINARIO 	
KIT	●	N° 4	—	K.050.1.1.C	Min. 600 mm	—	4x
			—	K.050.1.1.S	Min. 600 mm	—	4x
BLISTER	●	N° 4	—	B.050.1.1.C150	700 ÷ 850 mm	1500 mm	4x
		N° 5	—	B.050.1.1.C165	860 ÷ 950 mm	1650 mm	4x
		N° 5	—	B.050.1.1.C200	960 ÷ 1100 mm	2000 mm	4x
		N° 6	—	B.050.1.1.C250	1110 ÷ 1350 mm	2500 mm	4x
		N° 7	—	B.050.1.1.C300	1360 ÷ 1600 mm	3000 mm	4x
		—	—	B.050.1.1.S150	700 ÷ 850 mm	1500 mm	4x
		—	—	B.050.1.1.S165	860 ÷ 950 mm	1650 mm	4x
		—	—	B.050.1.1.S200	960 ÷ 1100 mm	2000 mm	4x
		—	—	B.050.1.1.S250	1110 ÷ 1350 mm	2500 mm	4x
		—	—	B.050.1.1.S300	1360 ÷ 1600 mm	3000 mm	4x

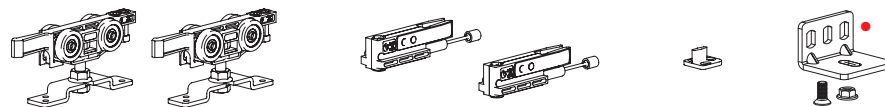

ART. 1280
(8000.01280)
(8010.01280)

FLUID



50 kg



N.2 Shock absorber
N.2 Fermi a pinza
ammortizzati



Ball bearings
Cuscinetti a sfera

			OLD CODE	NEW CODE		TRACK-BINARIO 	
KIT	●	N° 4	—	K.050.3.1.C	Min. 600 mm	—	5x
			—	K.050.3.1.S	Min. 600 mm	—	5x
BLISTER	●	N° 4	—	B.050.3.1.C150	700 ÷ 850 mm	1500 mm	4x
		N° 5	—	B.050.3.1.C165	860 ÷ 950 mm	1650 mm	4x
		N° 5	—	B.050.3.1.C200	960 ÷ 1100 mm	2000 mm	4x
		N° 6	—	B.050.3.1.C250	1110 ÷ 1350 mm	2500 mm	4x
		N° 7	—	B.050.3.1.C300	1360 ÷ 1600 mm	3000 mm	4x
		—	—	B.050.3.1.S150	700 ÷ 850 mm	1500 mm	4x
		—	—	B.050.3.1.S165	860 ÷ 950 mm	1650 mm	4x
		—	—	B.050.3.1.S200	960 ÷ 1100 mm	2000 mm	4x
		—	—	B.050.3.1.S250	1110 ÷ 1350 mm	2500 mm	4x
		—	—	B.050.3.1.S300	1360 ÷ 1600 mm	3000 mm	4x

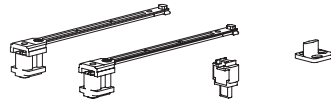
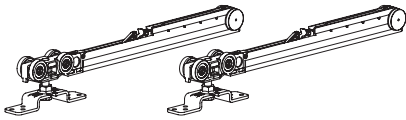

ART. 1280
(8000.01280)
(8010.01280)

		OLD CODE	NEW CODE		TRACK-BINARIO		
KIT	•	N° 5	—	K.080.2.1.C	Min. 740 mm	—	4x
		—	—	K.080.2.1.S	Min. 740 mm	—	4x
BLISTER	•	N° 4	—	B.080.2.1.C150	740 ÷ 850 mm	1500 mm	4x
		N° 5	—	B.080.2.1.C165	860 ÷ 950 mm	1650 mm	4x
		N° 5	—	B.080.2.1.C200	960 ÷ 1100 mm	2000 mm	4x
		N° 6	—	B.080.2.1.C250	1110 ÷ 1350 mm	2500 mm	4x
		N° 7	—	B.080.2.1.C300	1360 ÷ 1600 mm	3000 mm	4x
		—	—	B.080.2.1.S150	740 ÷ 850 mm	1500 mm	4x
		—	—	B.080.2.1.S165	860 ÷ 950 mm	1650 mm	4x
		—	—	B.080.2.1.S200	960 ÷ 1100 mm	2000 mm	4x
		—	—	B.080.2.1.S250	1110 ÷ 1350 mm	2500 mm	4x
		—	—	B.080.2.1.S300	1360 ÷ 1600 mm	3000 mm	4x



80 kg



N.2 Fluid dampers
N.2 Fermi ammortizzati
Fluid



Ball bearings
Cuscinetti a sfera

FLUID

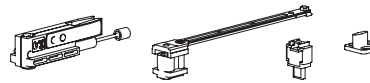
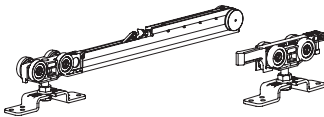

ART. 1280
(8000.01280)
(8010.01280)

		OLD CODE	NEW CODE		TRACK-BINARIO		
KIT	•	N° 5	—	K.080.1.1.C	Min. 600 mm	—	4x
		—	—	K.080.1.1.S	Min. 600 mm	—	4x
BLISTER	•	N° 4	—	B.080.1.1.C150	700 ÷ 850 mm	1500 mm	4x
		N° 5	—	B.080.1.1.C165	860 ÷ 950 mm	1650 mm	4x
		N° 5	—	B.080.1.1.C200	960 ÷ 1100 mm	2000 mm	4x
		N° 6	—	B.080.1.1.C250	1110 ÷ 1350 mm	2500 mm	4x
		N° 7	—	B.080.1.1.C300	1360 ÷ 1600 mm	3000 mm	4x
		—	—	B.080.1.1.S150	700 ÷ 850 mm	1500 mm	4x
		—	—	B.080.1.1.S165	860 ÷ 950 mm	1650 mm	4x
		—	—	B.080.1.1.S200	960 ÷ 1100 mm	2000 mm	4x
		—	—	B.080.1.1.S250	1110 ÷ 1350 mm	2500 mm	4x
		—	—	B.080.1.1.S300	1360 ÷ 1600 mm	3000 mm	4x



80 kg



N.1 Fluid damper
N.1 Fermo ammortizzato
Fluid



N.1 Shock absorber
N.1 Fermo a pinza
ammortizzato



Ball bearings
Cuscinetti a sfera

FLUID

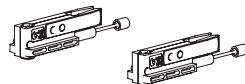
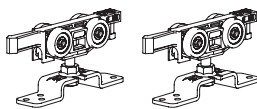

ART. 1280
(8000.01280)
(8010.01280)

		OLD CODE	NEW CODE		TRACK-BINARIO		
KIT	•	N° 5	—	K.080.3.1.C	Min. 600 mm	—	5x
		—	—	K.080.3.1.S	Min. 600 mm	—	5x
BLISTER	•	N° 4	—	B.080.3.1.C150	700 ÷ 850 mm	1500 mm	4x
		N° 5	—	B.080.3.1.C165	860 ÷ 950 mm	1650 mm	4x
		N° 5	—	B.080.3.1.C200	960 ÷ 1100 mm	2000 mm	4x
		N° 6	—	B.080.3.1.C250	1110 ÷ 1350 mm	2500 mm	4x
		N° 7	—	B.080.3.1.C300	1360 ÷ 1600 mm	3000 mm	4x
		—	—	B.080.3.1.S150	700 ÷ 850 mm	1500 mm	4x
		—	—	B.080.3.1.S165	860 ÷ 950 mm	1650 mm	4x
		—	—	B.080.3.1.S200	960 ÷ 1100 mm	2000 mm	4x
		—	—	B.080.3.1.S250	1110 ÷ 1350 mm	2500 mm	4x
		—	—	B.080.3.1.S300	1360 ÷ 1600 mm	3000 mm	4x



80 kg



N.2 Shock absorber
N.2 Fermi a pinza
ammortizzati



Ball bearings
Cuscinetti a sfera

FLUID

Classic

Slides with standard bracket
Scorrevoli con staffa normale

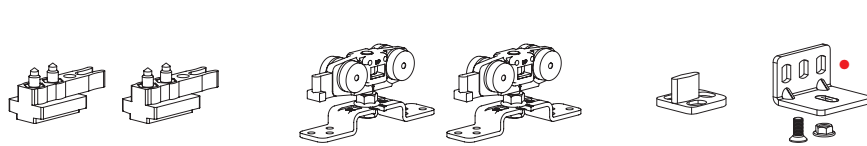

80 kg



N.2 Standard stopper
N.2 Fermi standard



Turned wheels
Ruote tornite

				OLD CODE	NEW CODE		TRACK-BINARIO 	
KIT	●	N° 5	80/T/G/NOR/CON	K.080.0.1.C	Min. 600 mm	—	5x	
		—	80/T/G/NOR/SEN	K.080.0.1.S	Min. 600 mm	—	5x	
BLISTER	●	N° 4	80/T/P/NR150CON	B.080.0.1.C150	700 ÷ 850 mm	1500 mm	4x	
		N° 5	80/T/P/NR165CON	B.080.0.1.C165	860 ÷ 950 mm	1650 mm	4x	
		N° 5	80/T/P/NR200CON	B.080.0.1.C200	960 ÷ 1100 mm	2000 mm	4x	
		N° 6	80/T/P/NR250CON	B.080.0.1.C250	1110 ÷ 1350 mm	2500 mm	4x	
		N° 7	80/T/P/NR300CON	B.080.0.1.C300	1360 ÷ 1600 mm	3000 mm	4x	
		—	80/T/P/NR150SEN	B.080.0.1.S150	700 ÷ 850 mm	1500 mm	4x	
		—	80/T/P/NR165SEN	B.080.0.1.S165	860 ÷ 950 mm	1650 mm	4x	
		—	80/T/P/NR200SEN	B.080.0.1.S200	960 ÷ 1100 mm	2000 mm	4x	
		—	80/T/P/NR250SEN	B.080.0.1.S250	1110 ÷ 1350 mm	2500 mm	4x	
		—	80/T/P/NR300SEN	B.080.0.1.S300	1360 ÷ 1600 mm	3000 mm	4x	

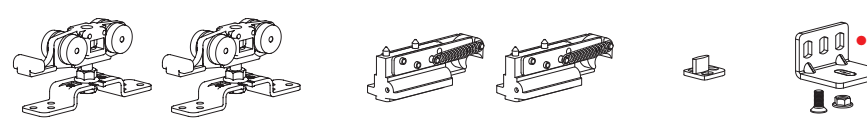

80 kg



N.2 Hydraulic stopper
N.2 Fermi idraulici



Suitable for naval sector
Adatto per settore navale



Turned wheels
Ruote tornite

				OLD CODE	NEW CODE		TRACK-BINARIO 	
KIT	●	N° 5	80/TG/NR/C/FAN	K.080.4.1.C	Min. 700 mm	—	5x	
		—	80/TG/NR/S/FAN	K.080.4.1.S	Min. 700 mm	—	5x	
BLISTER	●	N° 4	80T/PNR150CFAN	B.080.4.1.C150	700 ÷ 850 mm	1500 mm	4x	
		N° 5	80T/PNR165CFAN	B.080.4.1.C165	860 ÷ 950 mm	1650 mm	4x	
		N° 5	80T/PNR200CFAN	B.080.4.1.C200	960 ÷ 1100 mm	2000 mm	4x	
		N° 6	80T/PNR250CFAN	B.080.4.1.C250	1110 ÷ 1350 mm	2500 mm	4x	
		N° 7	80T/PNR300CFAN	B.080.4.1.C300	1360 ÷ 1600 mm	3000 mm	4x	
		—	80T/PNR150SFAN	B.080.4.1.S150	700 ÷ 850 mm	1500 mm	4x	
		—	80T/PNR165SFAN	B.080.4.1.S165	860 ÷ 950 mm	1650 mm	4x	
		—	80T/PNR200SFAN	B.080.4.1.S200	960 ÷ 1100 mm	2000 mm	4x	
		—	80T/PNR250SFAN	B.080.4.1.S250	1110 ÷ 1350 mm	2500 mm	4x	
		—	80T/PNR300SFAN	B.080.4.1.S300	1360 ÷ 1600 mm	3000 mm	4x	

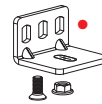
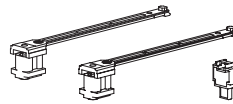
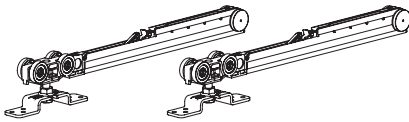

ART. 1280
(8000.01280)
(8010.01280)

		OLD CODE	NEW CODE		TRACK-BINARIO 		
KIT	●	N° 6	—	K.120.2.1.C	Min. 740 mm	—	4x
	—	—	—	K.120.2.1.S	Min. 740 mm	—	4x
BLISTER	●	N° 4	—	B.120.2.1.C150	740 ÷ 850 mm	1500 mm	4x
		N° 5	—	B.120.2.1.C165	860 ÷ 950 mm	1650 mm	4x
		N° 5	—	B.120.2.1.C200	960 ÷ 1100 mm	2000 mm	4x
		N° 6	—	B.120.2.1.C250	1110 ÷ 1350 mm	2500 mm	4x
		N° 7	—	B.120.2.1.C300	1360 ÷ 1600 mm	3000 mm	4x
	—	—	—	B.120.2.1.S150	740 ÷ 850 mm	1500 mm	4x
	—	—	—	B.120.2.1.S165	860 ÷ 950 mm	1650 mm	4x
	—	—	—	B.120.2.1.S200	960 ÷ 1100 mm	2000 mm	4x
	—	—	—	B.120.2.1.S250	1110 ÷ 1350 mm	2500 mm	4x
	—	—	—	B.120.2.1.S300	1360 ÷ 1600 mm	3000 mm	4x



120 kg



N.2 Fluid dampers



N.2 Fermi ammortizzati
Fluid



Ball bearings
Cuscinetti a sfera

FLUID

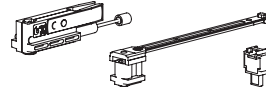
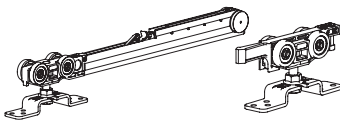

ART. 1280
(8000.01280)
(8010.01280)

		OLD CODE	NEW CODE		TRACK-BINARIO 		
KIT	●	N° 6	—	K.120.1.1.C	Min. 600 mm	—	4x
	—	—	—	K.120.1.1.S	Min. 600 mm	—	4x
BLISTER	●	N° 4	—	B.120.1.1.C150	700 ÷ 850 mm	1500 mm	4x
		N° 5	—	B.120.1.1.C165	860 ÷ 950 mm	1650 mm	4x
		N° 5	—	B.120.1.1.C200	960 ÷ 1100 mm	2000 mm	4x
		N° 6	—	B.120.1.1.C250	1110 ÷ 1350 mm	2500 mm	4x
		N° 7	—	B.120.1.1.C300	1360 ÷ 1600 mm	3000 mm	4x
	—	—	—	B.120.1.1.S150	700 ÷ 850 mm	1500 mm	4x
	—	—	—	B.120.1.1.S165	860 ÷ 950 mm	1650 mm	4x
	—	—	—	B.120.1.1.S200	960 ÷ 1100 mm	2000 mm	4x
	—	—	—	B.120.1.1.S250	1110 ÷ 1350 mm	2500 mm	4x
	—	—	—	B.120.1.1.S300	1360 ÷ 1600 mm	3000 mm	4x



120 kg



N.1 Fluid damper



N.1 Fermo ammortizzato
Fluid



N.1 Shock absorber
N.1 Fermo a pinza
ammortizzato



Ball bearings
Cuscinetti a sfera

FLUID

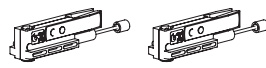
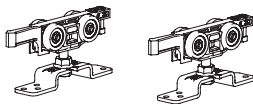

ART. 1280
(8000.01280)
(8010.01280)

		OLD CODE	NEW CODE		TRACK-BINARIO 		
KIT	●	N° 6	—	K.120.3.1.C	Min. 600 mm	—	5x
	—	—	—	K.120.3.1.S	Min. 600 mm	—	5x
BLISTER	●	N° 4	—	B.120.3.1.C150	700 ÷ 850 mm	1500 mm	4x
		N° 5	—	B.120.3.1.C165	860 ÷ 950 mm	1650 mm	4x
		N° 5	—	B.120.3.1.C200	960 ÷ 1100 mm	2000 mm	4x
		N° 6	—	B.120.3.1.C250	1110 ÷ 1350 mm	2500 mm	4x
		N° 7	—	B.120.3.1.C300	1360 ÷ 1600 mm	3000 mm	4x
	—	—	—	B.120.3.1.S150	700 ÷ 850 mm	1500 mm	4x
	—	—	—	B.120.3.1.S165	860 ÷ 950 mm	1650 mm	4x
	—	—	—	B.120.3.1.S200	960 ÷ 1100 mm	2000 mm	4x
	—	—	—	B.120.3.1.S250	1110 ÷ 1350 mm	2500 mm	4x
	—	—	—	B.120.3.1.S300	1360 ÷ 1600 mm	3000 mm	4x



120 kg



N.2 Shock absorber
N.2 Fermi a pinza
ammortizzati



Ball bearings
Cuscinetti a sfera

FLUID

Classic

Slides with standard bracket
Scorrevoli con staffa normale

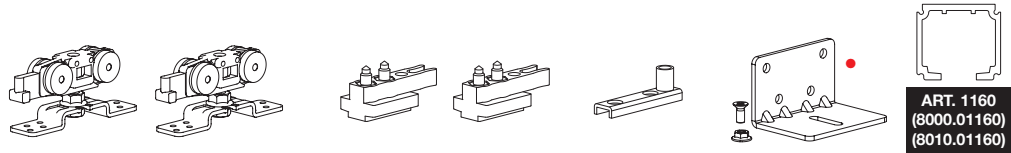

160 kg



N.2 Standard stoppers
N.2 Fermi standard



Turned wheels
Ruote tornite

			OLD CODE	NEW CODE		TRACK-BINARIO	
KIT	●	N° 6	160/T/G/NOR/CON	K.160.0.1.C	Min. 700 mm	—	5x
		—	160/T/G/NOR/SEN	K.160.0.1.S	Min. 700 mm	—	5x
BLISTER	●	N° 6	160/T/P/NR200CO	B.160.0.1.C200	960 ÷ 1100 mm	2000 mm	4x
		N° 7	160/T/P/NR250SE	B.160.0.1.C250	1110 ÷ 1350 mm	2500 mm	4x
		N° 8	160/T/P/NR300CO	B.160.0.1.C300	1360 ÷ 1600 mm	3000 mm	4x
		—	160/T/P/NR200SE	B.160.0.1.S200	960 ÷ 1100 mm	2000 mm	4x
		—	160/T/P/NR250SE	B.160.0.1.S250	1110 ÷ 1350 mm	2500 mm	4x
		—	160/T/P/NR300SE	B.160.0.1.S300	1360 ÷ 1600 mm	3000 mm	4x

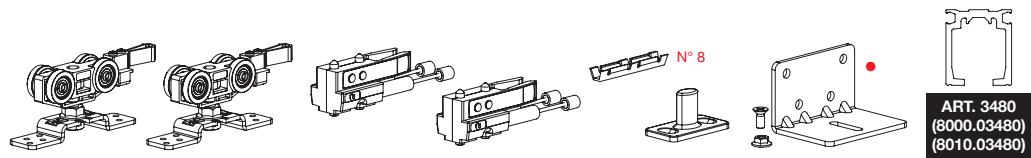

180 kg



N.2 Shock absorber
N.2 Fermi a pinza
ammortizzati



Ball bearings
Cuscinetti a sfera

			OLD CODE	NEW CODE		TRACK-BINARIO	
KIT	●	N° 6	—	K.180.3.1.C	Min. 700 mm	—	5x
		—	—	K.180.3.1.S	Min. 700 mm	—	5x
BLISTER	●	N° 6	—	B.180.3.1.C200	960 ÷ 1100 mm	2000 mm	4x
		N° 7	—	B.180.3.1.C250	1110 ÷ 1350 mm	2500 mm	4x
		N° 8	—	B.180.3.1.C300	1360 ÷ 1600 mm	3000 mm	4x
		—	—	B.180.3.1.S200	960 ÷ 1100 mm	2000 mm	4x
		—	—	B.180.3.1.S250	1110 ÷ 1350 mm	2500 mm	4x
		—	—	B.180.3.1.S300	1360 ÷ 1600 mm	3000 mm	4x

FLUID

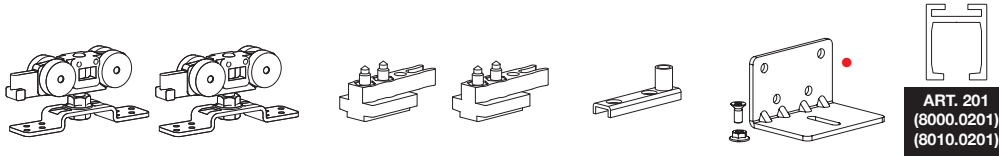

			OLD CODE	NEW CODE		TRACK-BINARIO	
KIT	●	N° 7	240/T/G/NOR/CON	K.240.0.1.C	Min. 700 mm	—	5x
		—	240/T/G/NOR/SEN	K.240.0.1.S	Min. 700 mm	—	5x
BLISTER	●	N° 6	240/T/P/NR200CO	B.240.0.1.C200	960 ÷ 1100 mm	2000 mm	4x
		N° 7	240/T/P/NR250CO	B.240.0.1.C250	1110 ÷ 1350 mm	2500 mm	4x
		N° 8	240/T/P/NR300CO	B.240.0.1.C300	1360 ÷ 1600 mm	3000 mm	4x
		—	240/T/P/NR200SE	B.240.0.1.S200	960 ÷ 1100 mm	2000 mm	4x
		—	240/T/P/NR250SE	B.240.0.1.S250	1110 ÷ 1350 mm	2500 mm	4x
		—	240/T/P/NR300SE	B.240.0.1.S300	1360 ÷ 1600 mm	3000 mm	4x



240 kg



N.2 Standard stoppers
N.2 Fermi standard



Turned wheels
Ruote tornite

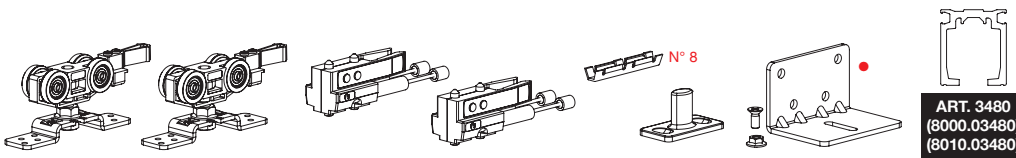

			OLD CODE	NEW CODE		TRACK-BINARIO	
KIT	●	N° 7	—	K.250.3.1.C	Min. 800 mm	—	5x
		—	—	K.250.3.1.S	Min. 800 mm	—	5x
BLISTER	●	N° 6	—	B.250.3.1.C200	960 ÷ 1100 mm	2000 mm	4x
		N° 7	—	B.250.3.1.C250	1110 ÷ 1350 mm	2500 mm	4x
		N° 8	—	B.250.3.1.C300	1360 ÷ 1600 mm	3000 mm	4x
		—	—	B.250.3.1.S200	960 ÷ 1100 mm	2000 mm	4x
		—	—	B.250.3.1.S250	1110 ÷ 1350 mm	2500 mm	4x
		—	—	B.250.3.1.S300	1360 ÷ 1600 mm	3000 mm	4x



250 kg



N.2 Shock absorber
N.2 Fermi a pinza
ammortizzati



Ball bearings
Cuscinetti a sfera

N.2 Soft damper stoppers
N.2 Fermi ammortizzati

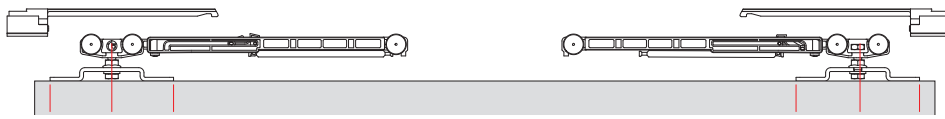

N.1 Soft damper stopper + N.1 Standard stopper
N.1 Fermo ammortizzato + N.1 Fermo standard

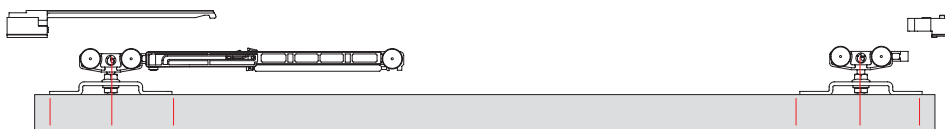

N.2 Standard stoppers
N.2 Fermi standard

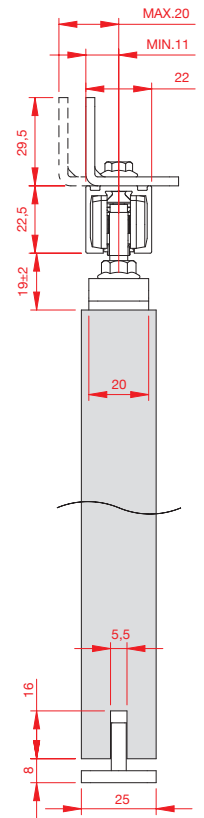
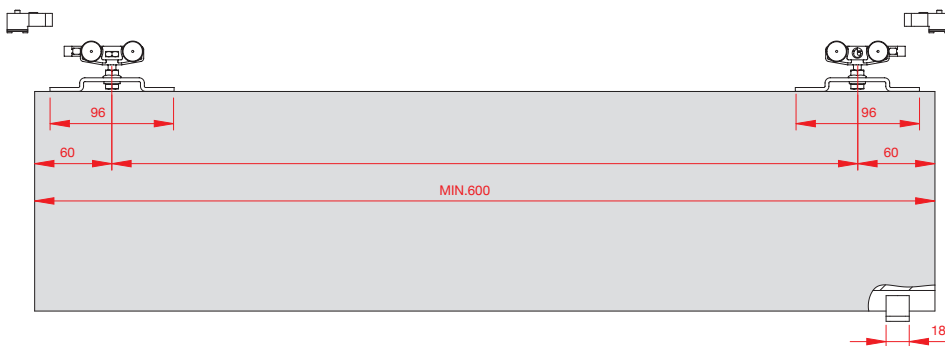

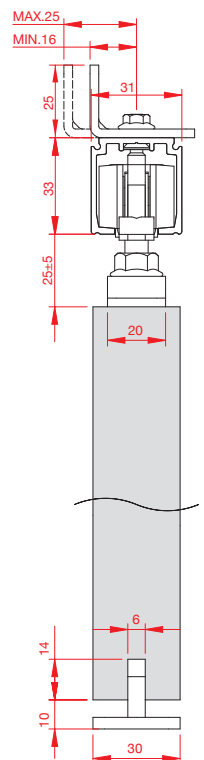
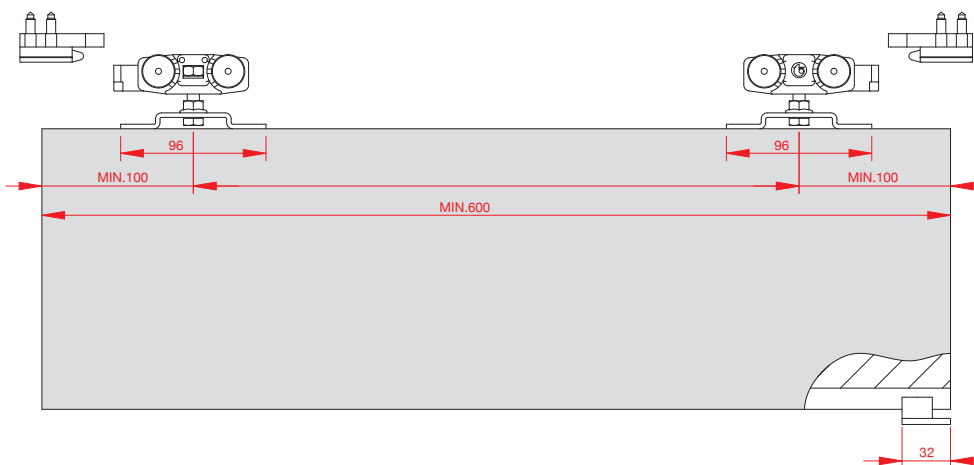

30 kg

N.2 Standard stoppers
N.2 Fermi standard



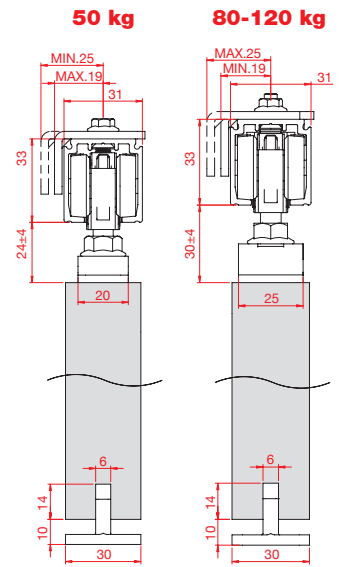
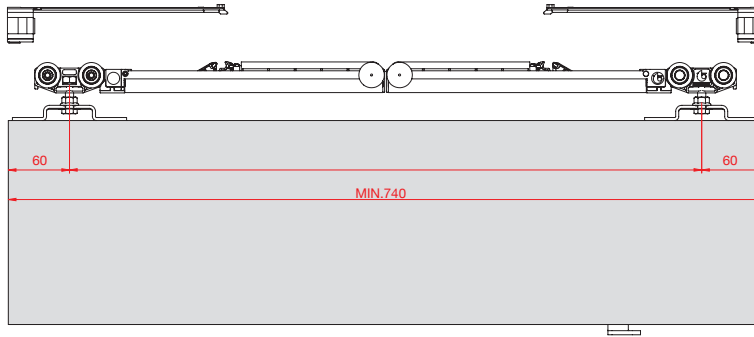

40 kg

N.2 Fluid dampers
N.2 Fermi ammortizzati Fluid

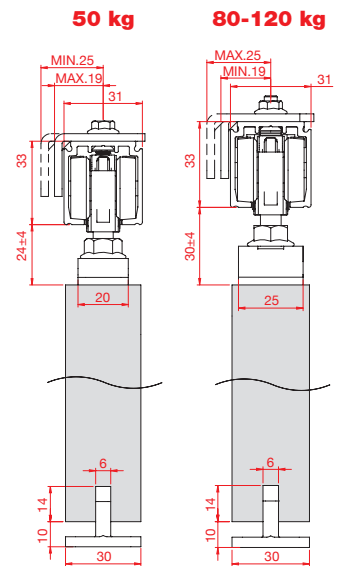
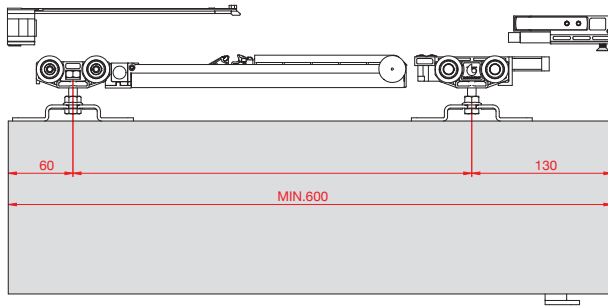

N.1 Fluid damper + N.1 Shock absorber
N.1 Fermo ammortizzato Fluid + N.1 Fermo a pinza ammortizzato



N.2 Shock absorber
N.2 Fermi a pinza ammortizzati

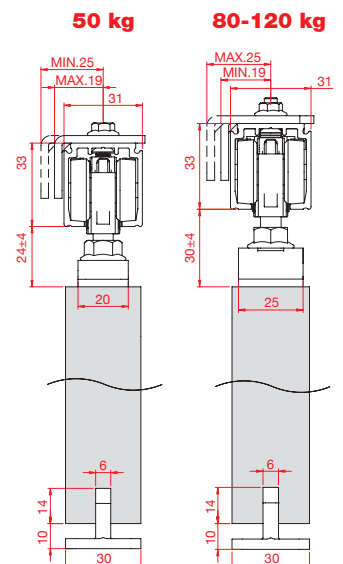
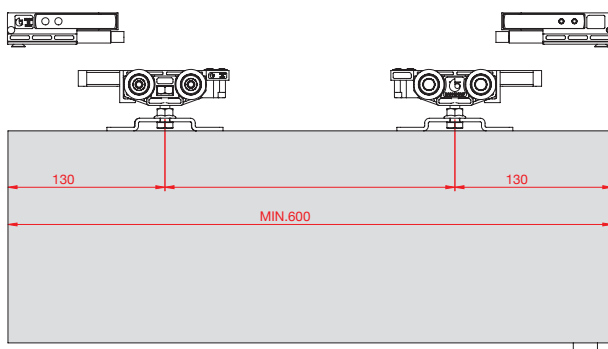

50 kg
80 kg
120 kg

FLUID

N.2 Standard stoppers
N.2 Fermi standard

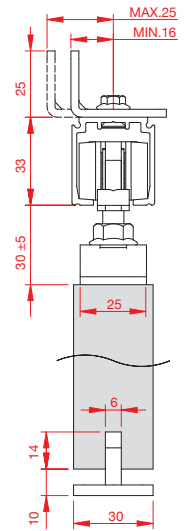
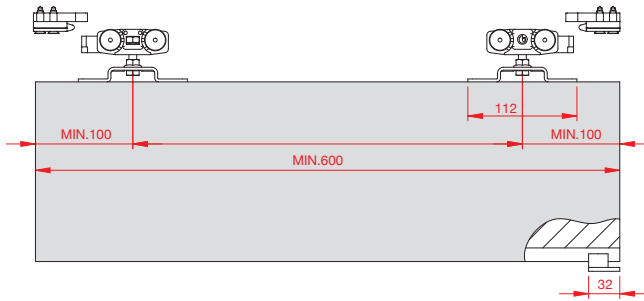

80 kg



N.2 Hydraulic stopper
N.2 Fermi idraulici

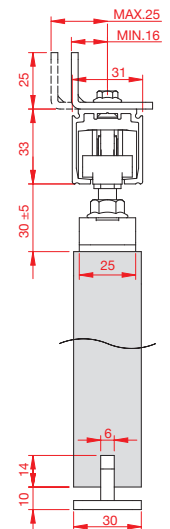
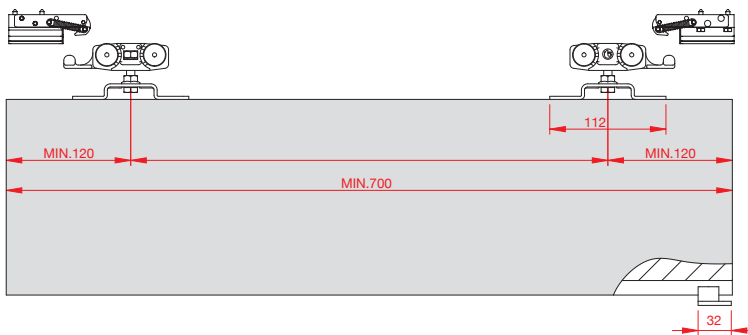

80 kg



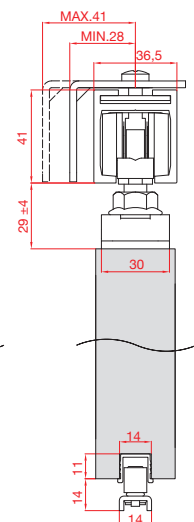
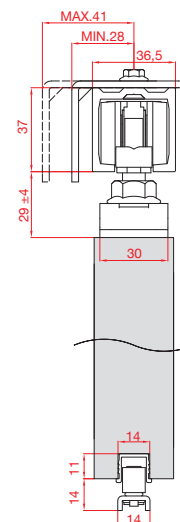
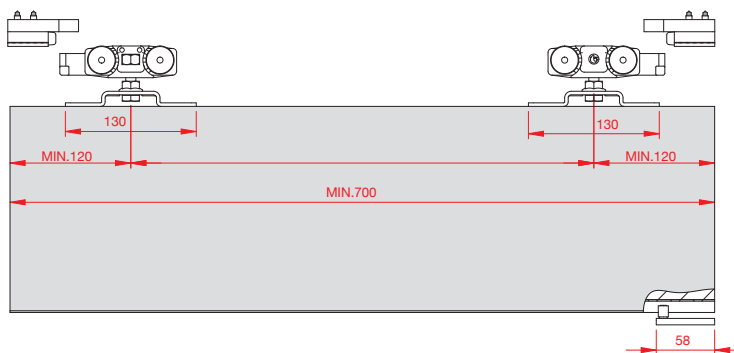

N.2 Standard stopper
N.2 Fermi standard

160 kg



N.2 Shock absorber
N.2 Fermi a pinza ammortizzati

180 kg

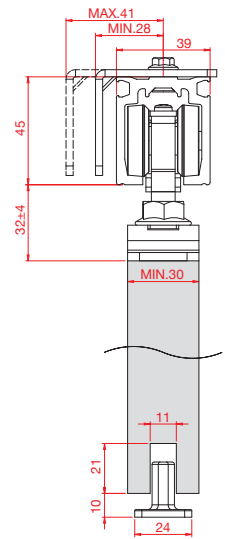
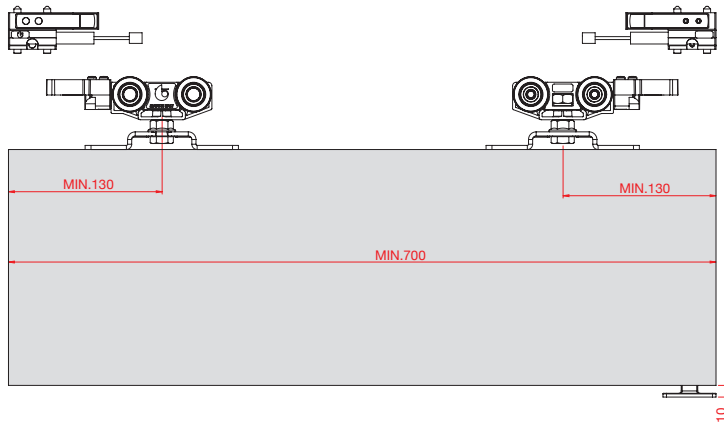

N.2 Standard stopper
N.2 Fermi standard

240 kg

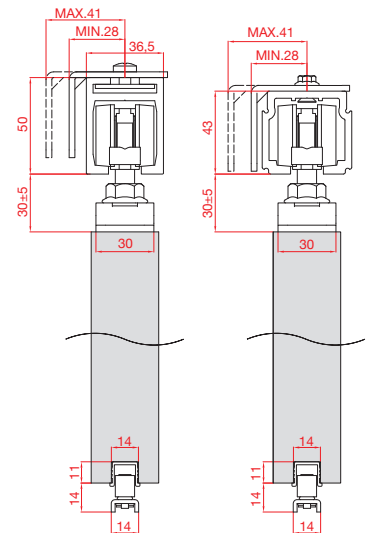
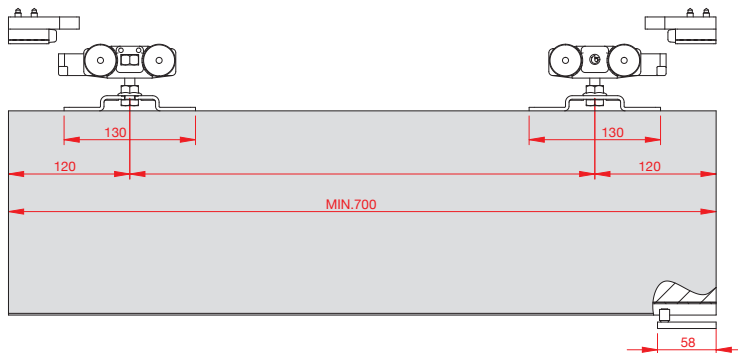

N.2 Shock absorber
N.2 Fermi a pinza ammortizzati

250 kg

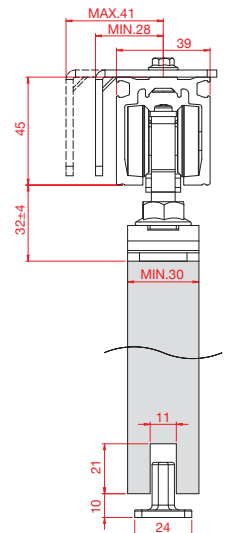
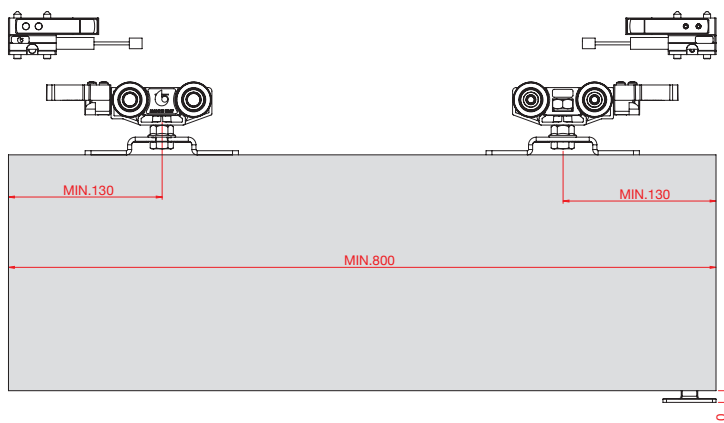

FLUID

FLUID



Terno Scorrevoli S.p.A.

**Via Ravenna, 4 - 20814 Varedo (MB) ITALY
Phone +39 0362 543001 - Fax +39 0362 582290**

**terno@ternoscorrevoli.com
www.ternoscorrevoli.com**