

# Chiudiporta aerodinamico 609

## *Surface mounted door closer 609*

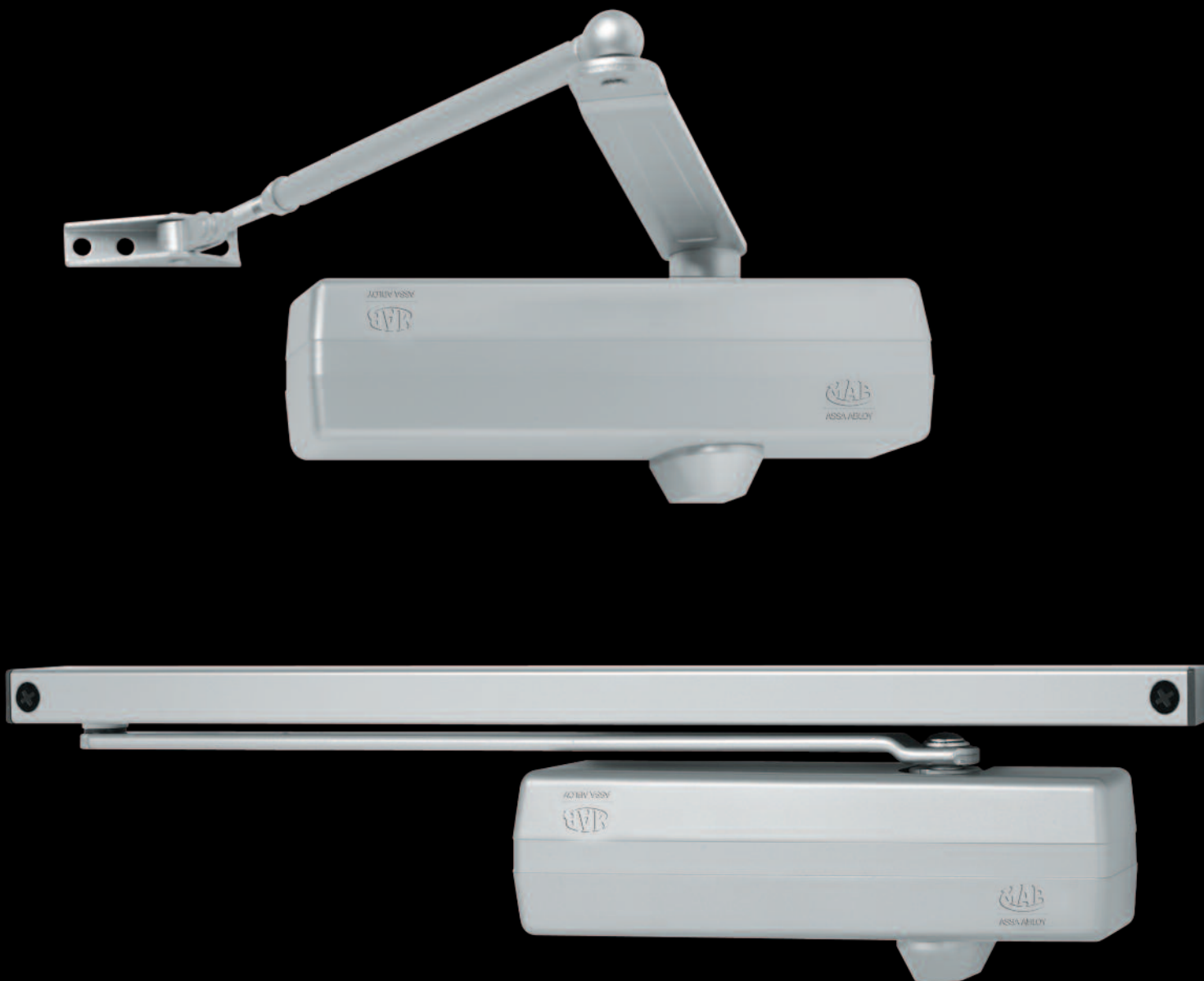

ASSA ABLOY, the global leader  
in door opening solutions



# Chiudiporta multifunzionale per uso gravoso

## *Multifunction heavy duty door closer*

### Caratteristiche tecniche:

- Corpo in ghisa
- Raccomandato per porte tagliafuoco (con braccio normale e a slitta)
- Conformità DIN EN1154 e **CE** certificata da MPA NRW (Germania)
- Chiusura da 180° controllata da due valvole idrauliche
- Scatto finale regolato da valvola.
- Installazione su profili stretti facilitata da piastra AC174 (optional)
- Utilizzabile con braccio standard (forze EN3-6 + **CE**), braccio fermaporta regolabile (forze EN3-6) e braccio a slitta (forza EN3 + **CE**), tutti da ordinare separatamente
- Custodia in ABS di alta resistenza agli impatti
- Finiture standard: argento, nero opaco.  
Altre finiture disponibili a richiesta

### Testo per capitoli

Chiudiporta in ghisa a forza variabile EN3-6, monodima, certificato **CE**, due valvole di velocità indipendenti, con angolo di scatto variabile, montabile con braccio a slitta EN3 certificato **CE**, tipo MAB 609.

### Features:

- Cast iron body
- Recommended for fire doors (regular and sliding arm mounting)
- Conformity DIN EN1154 and **CE** certified by MPA NRW (Germany)
- Closing from 180° controlled by two hydraulic valves
- Final latch controlled by valve
- Mounting on narrow profiles made easy by back plate AC174 (optional)
- Mounting with regular arm (variable force EN3-6 + **CE**), hold open arm (variable force EN3-6) and sliding arm (force EN3 + **CE**) to be ordered separately
- Cover in high impact resistance ABS  
Standard finishes: silver, matt black.  
Other finishes available on request

### Text for specifications

Cast iron body surface mounted closer with variable force EN3-6, one drilling template, certified **CE**, two independent speed valves, adjustable final latch angle, EN3 certified **CE** when mounted with sliding arm&rail, type MAB 609.



## Variazione della forza Force variations

I riferimenti **A-B-C** indicano il montaggio in forza **3-4-5**  
La successiva rotazione del piedino determina la forza **6**

The references **A-B-C** indicate the mounting to get force **3-4-5** respectively. When mounted at force **5**, rotation of attachment shoe will provide force **6**.

Forza **3**  
Force

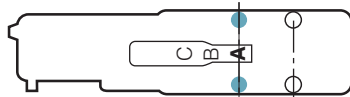

Forza **4**  
Force

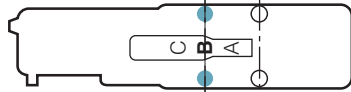

Forza **5**  
Force

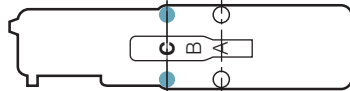

Forza **6**  
Force

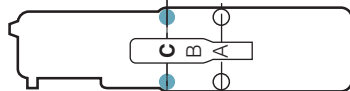

> 22 Nm

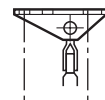

> 30 Nm

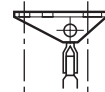

> 40 Nm

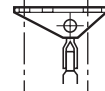

> 54 Nm

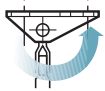

950 x 2300



1100 x 2400



1250 x 2500



1400 x 2500

## Regolazione della velocità di chiusura Closing speed adjustment

La valvola ① controlla la velocità da 180° a ~15°.

La valvola ② da ~15° a 0°.

La posizione del braccio regola l'angolo effettivo.

La velocità di chiusura nel settore ② può essere costante rispetto alla ①, più lenta o con colpo finale.

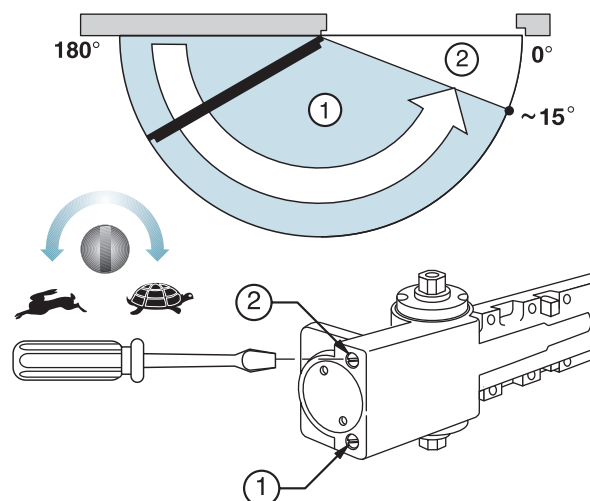

Valve ① controls the speed from 180° to ~15°.

Valve ② from ~15° to 0°.

Actual angle adjusted by the main arm position. Over arc ② the speed can be equal, slower or faster than speed ①.

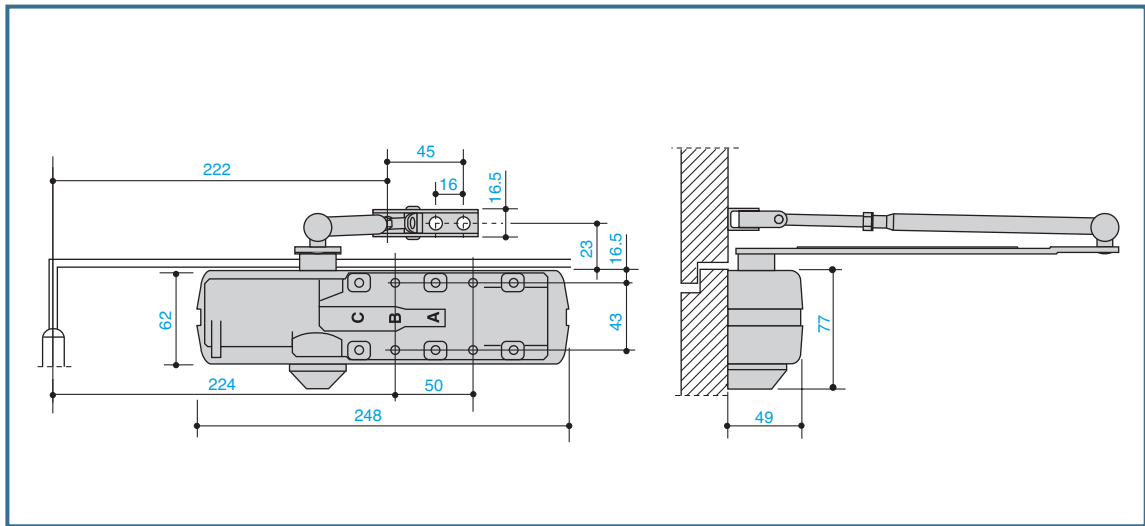

### CON BRACCIO A COMPASSO IN ACCIAIO

- Forza variabile EN 3-6
- Unica dima di foratura per quattro forze
- Conformità CE
- Adatto per porte tagliafuoco.
- Apertura fino a 180°
- Angolo di scatto finale regolabile
- Braccio in acciaio con snodo sferico.
- La leva può essere facilmente separata per:
  - esigenza di temporanea disattivazione dell'autochiusura
  - facilitazione di montaggio e manutenzione

### WITH REGULAR ARM IN STEEL

- Variable force EN 3-6
- One drilling template for all forces
- Conformity CE
- Suitable for fire doors
- Opening to 180°
- Adjustable angle of final latch
- Steel arm with ball&socket joint.
- Forearm can be easily detached:
  - to make installation easier
  - to temporarily disable the self closing action



### CON BRACCIO FERMAPORTA:

- Forza variabile EN 3-6
- Unica dima di foratura per quattro forze
- Angolo di scatto finale regolabile
- Angolo di fermo regolabile tra 80° e 100°
- Fermo inseribile e disinseribile
- Apertura fino a 180°
- Non adatto per porte tagliafuoco

### WITH HOLD OPEN ARM:

- Variable force EN 3-6
- One drilling template for all forces
- Adjustable angle of final latch
- Adjustable Hold Open angle between 80° - 100°
- ON/OFF hold open feature
- Opening to 180°
- Not suitable for fire doors

### MONTAGGIO NORMALE LATO CERNIERE STANDARD MOUNTING PULL SIDE

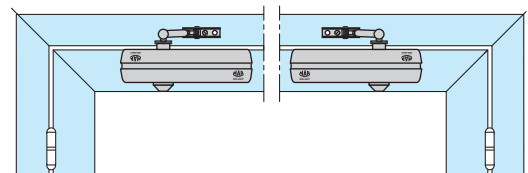

### MONTAGGIO ROVESCiato LATO OPPOSTO CERNIERE REVERSED MOUNTING PUSH SIDE

NOTA: Lo spessore della porta e l'interasse delle cerniere possono limitare l'angolo d'apertura.

NOTE: Door thickness and off-set hinges may limit the opening angle.

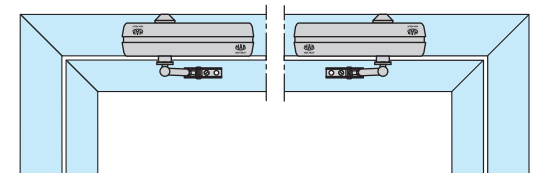

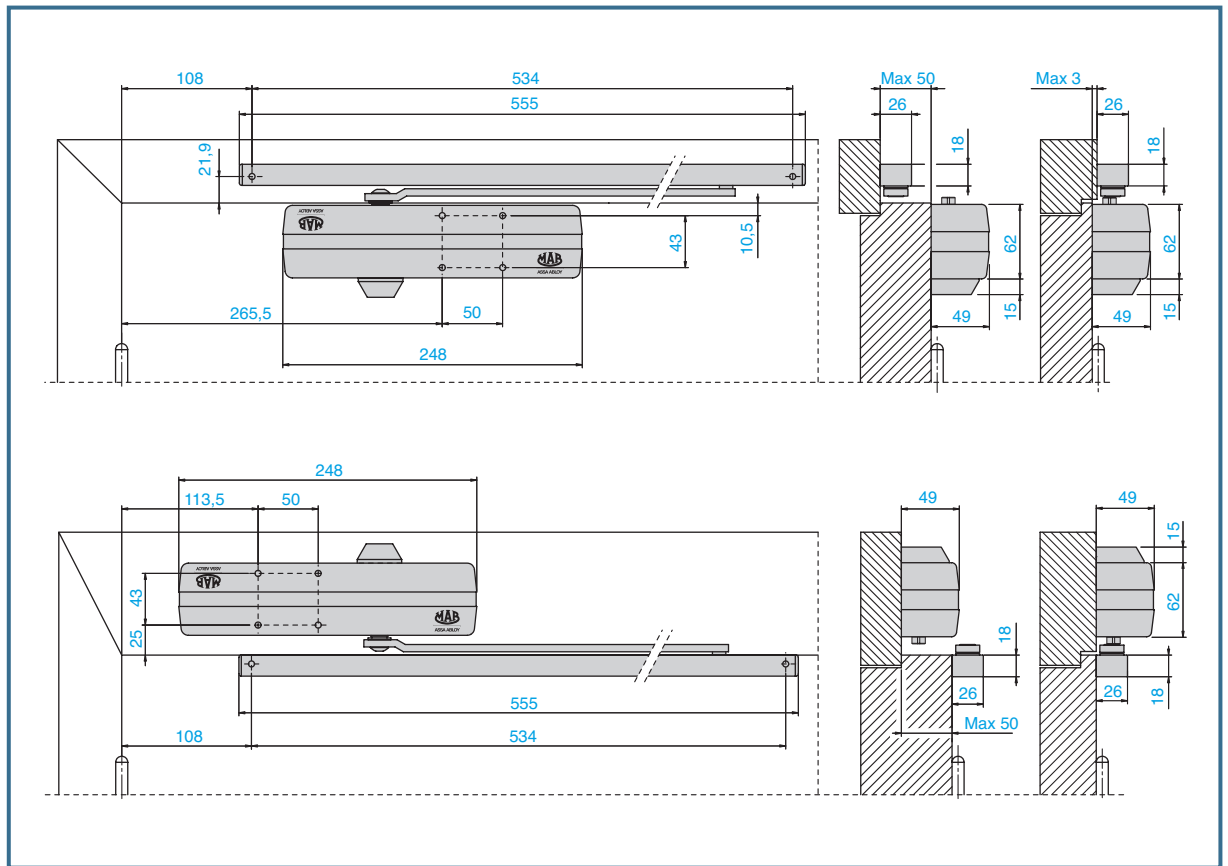

### CON BRACCIO A SLITTA

- Forza EN 3
- Conformità **CE**
- Adatto per porte tagliafuoco (senza fermaporta)
- A bassa coppia di apertura
- Fermaporta regolabile tra 85° e 125° (optional)
- Apertura fino a 180° anche con uso di fermaporta
- Limitatore di apertura (optional)

### WITH SLIDING ARM & RAIL

- Force EN 3
- **CE** Conformity
- Suitable for fire doors (without hold open)
- Low opening moment
- Adjustable hold open device (optional)
- Opening to 180° even with Hold Open
- Adjustable cushioned Back Stop (optional)

### MONTAGGIO NORMALE LATO CERNIERE

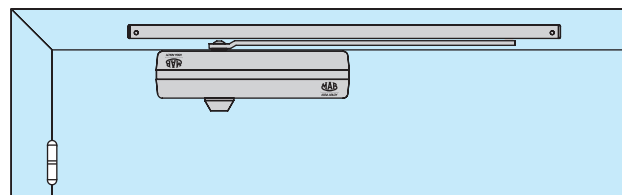

### STANDARD MOUNTING PULL SIDE

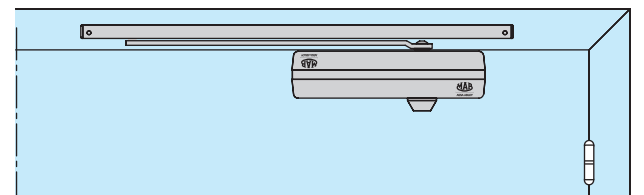

### MONTAGGIO ROVESCiato LATO CERNIERE

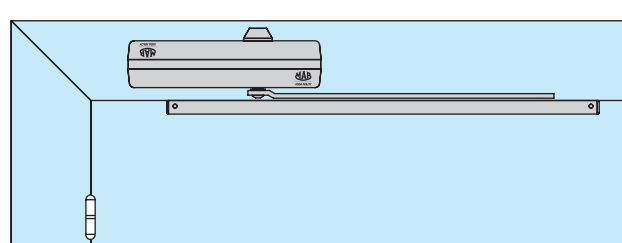

### REVERSED MOUNTING PULL SIDE

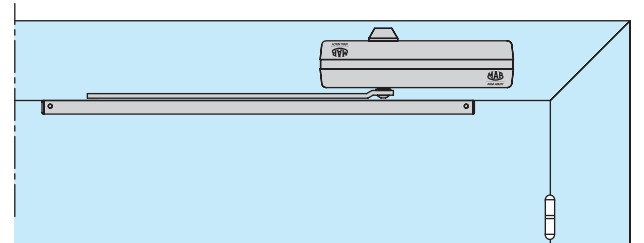

### Codice / Code

**AC618**

Kit Selettore di chiusura per 609 + Carry Barr  
 Kit closing coordinator for 609 + Carry Barr

#### Caratteristiche

- Coordinatore della chiusura basato su rivoluzionario meccanismo a catena.
- Adatto per porte destre e sinistre
- Semplice installazione
- Per montaggio standard lato cerniere
- Conformità EN1158 e CE certificata da AFNOR (Francia)
- Kit completo di coordinatore, chiudiporta e carry barr
- Cover in alluminio in finitura argento

#### Features

- Closing coordinator based on revolutionary chain mechanism.
- Can be used for left and right-handed doors
- Easy to install
- For standard mounting hinge side
- Conformity EN1158 and CE certified by AFNOR (France)
- Kit completed by closing coordinator, doorclosers and carry barr
- Aluminium cover in Silver finish

#### Testo per capitolati

Kit coordinatore di chiusura completo dei due chiudiporta tipo MAB 609 e carry barr, certificato CE e adatto per doppie porte di larghezza da 1400 mm a 1900 mm

#### Text for specifications

Kit closing coordinator completed with two MAB609 doorclosers and carry barr, certified CE and suitable for double leaf doors from 1400 mm to 1900 mm width

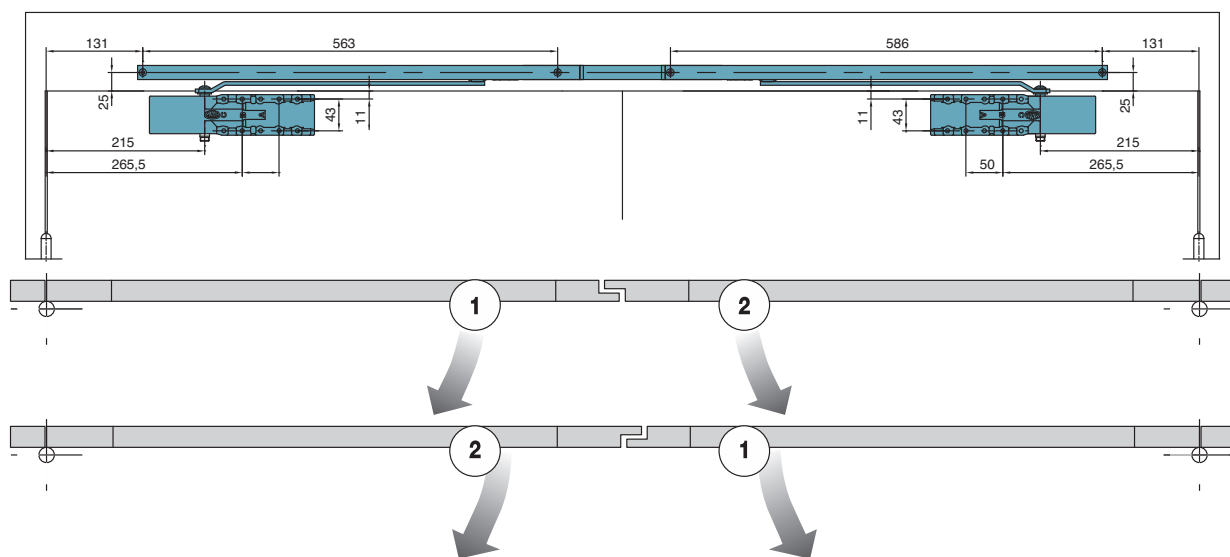

### Codice / Code

**AC 593**

Braccio normale in acciaio. Tenditore separabile.  
 Regular arm in steel. Detachable forearm.

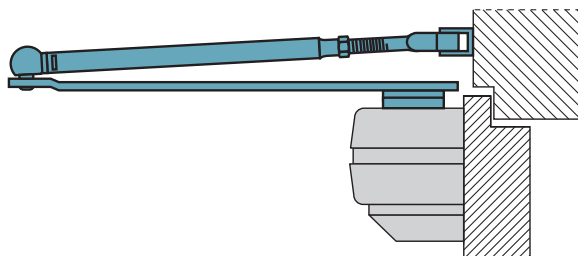

### Codice / Code

**AC 572**

Braccio e slitta.  
 Sliding arm and rail.

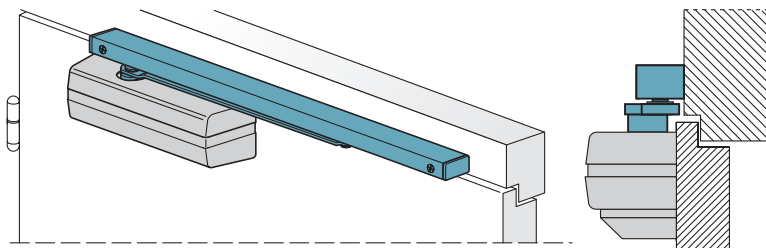

## Codice / Code

AC 607

Braccio fermaporta regolabile intercambiabile con braccio normale. Zona ideale di lavoro tra 80° e 100°. Fermo inseribile e disinseribile a mezzo pulsante.

*Adjustable hold open arm fully interchangeable with regular arm. Ideal hold open angle 80° - 100°. Hold open can be activated/deactivated by pressing the trigger.*

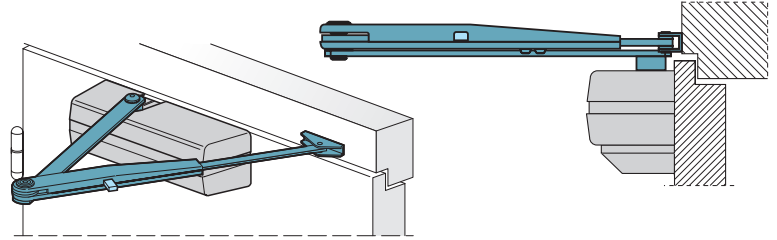

## Codice / Code

AC 174

Piastra di montaggio. Facilita l'installazione su profili stretti e su porte preforate secondo norme DIN. Corredata di distanziali in nylon da usarsi in caso di scalini.

*Back plate. Enables easy installation on very narrow profiles and in case of predrilled doors as per DIN specifications. A set of spacers is supplied to overcome problems in case of steps.*

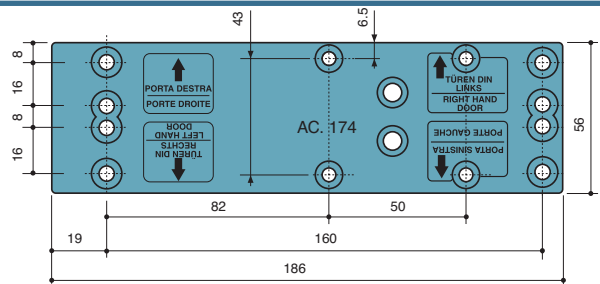

## Codice / Code

AC 596

Limitatore di apertura. Non sostituisce un fermo a pavimento. Cushioned Back Stop. Does not replace floor stopper.

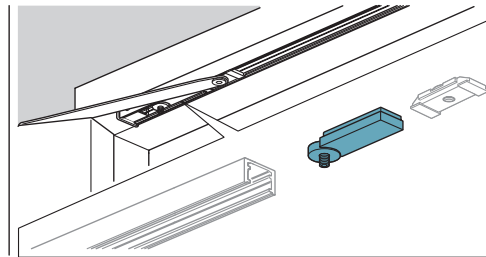
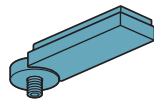

85° - 125° MAX

STOP

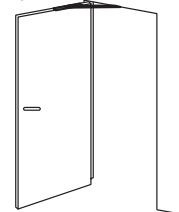

## Codice / Code

AC 581

Dispositivo fermaporta per slitta. Fermo regolabile tra 85° e 125°.

*Hold Open device for rail. Angle adjustable between 85° - 125°.*

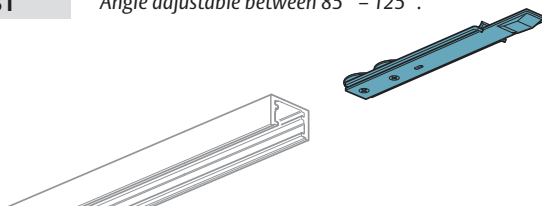

## Codice / Code

AC 57

Piastrina di innalzamento. Shoe attachment plate.

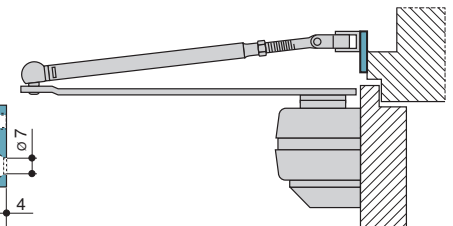
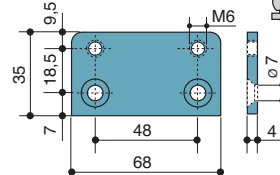

## Codice / Code

AC 178

Piastra di abbassamento. Drop plate.

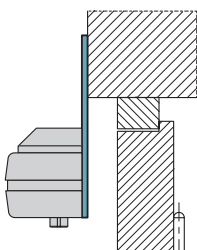
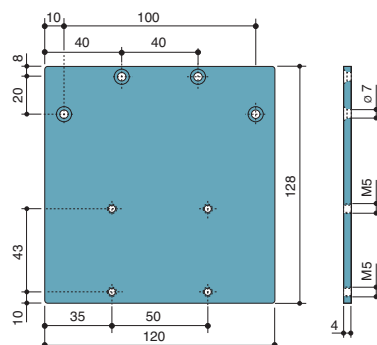

## Codice / Code

AC 179

Piastra angolare. Bracket.

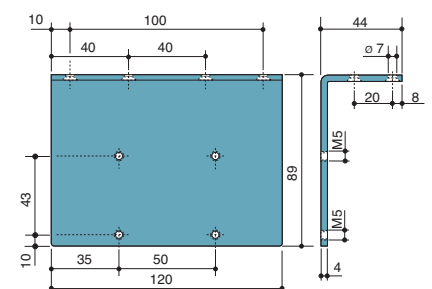
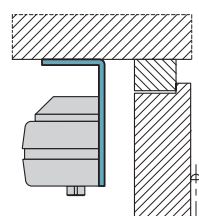



ASSA ABLOY Italia S.p.A.  
Via Bovaresa 13 - 40017 San Giovanni in Persiceto (BO) Italy  
Tel. +39 051 6812411 - Fax +39 051 827486  
[info@assaabloy.it](mailto:info@assaabloy.it) - [www.assaabloy.it](http://www.assaabloy.it)

ASSA ABLOY Italia S.p.A. si riserva di apportare in qualunque momento e senza preavviso le modifiche necessarie per migliorare ed evolvere le caratteristiche dei propri prodotti. Fotografie, illustrazioni e descrizioni sono da ritenersi indicative.  
ASSA ABLOY Italia S.p.A. reserves the right at any time and without notice, the necessary modifications in order to improve and evolve the characteristics of their products. Photographs, illustrations and descriptions ought to be considered as indicative.

H001E07 / 01-2013

ASSA ABLOY is the global leader in door opening solutions, dedicated to satisfying end-user needs for security, safety and convenience.

[www.assaabloy.com](http://www.assaabloy.com)

